

Right Angle Geared Motor



GMP61238



Specification

Model No.	Rated Voltage V	No-Load		Load		Locked Torque N.m	Locked Current A	
		Speed RPM	Current A	Torque N.m	Speed RPM			Current A
		GMP61238 R/L	12	65±10	≤3			3

Outline Drawing

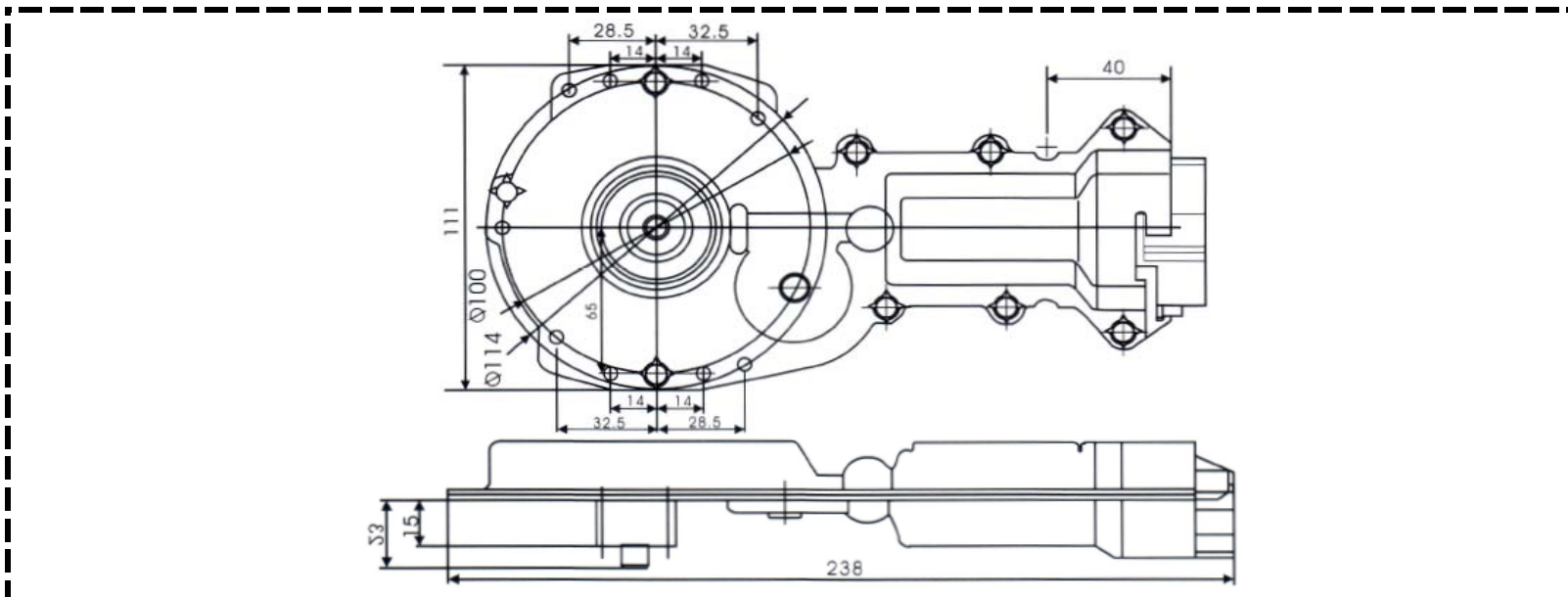

Performance Curve

